

Ecoguss project drain DN 70, vert., Variofix, Slotted cover

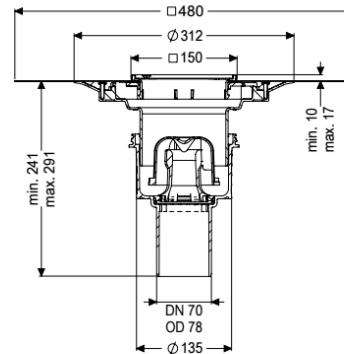
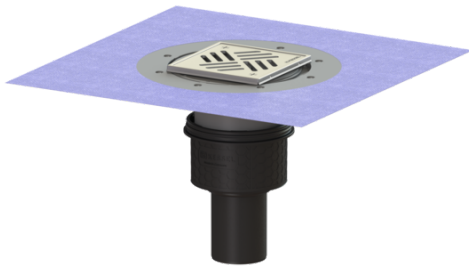

Article information

Item no.: 48478.51
 GTIN: 4026092034378
 Price group: 40

Advantages

- High-tech Ecoguss composite material
- Highest fire protection standards
- Scientifically confirmed sound protection effect

Description

The Ecoguss project drain with connection flange is used for point drainage and is equipped with a removable odour trap as well as a lip seal and a temporary protective cover. The recyclable composite material Ecoguss meets the highest noise protection requirements, is temperature-resistant, resistant to aggressive media, and has a permanently corrosion-free surface. It is also briefly flammable from 100 to 400 degrees Celsius. The outlet socket is suitable for connection to SML cast iron pipes. Separate equipotential bonding is not necessary.

Variant

System:	125
Waterproofing layer on the upper section:	Enclosed sealing collar to be glued (bd) according to DIN 18534
Waterproofing layer on the drain body:	Connection flange
Sealing water height:	50 mm

General characteristics

Standard:	EN 1253-1
Nominal size (DN):	70
Outer diameter (OD):	78 mm
Approval:	Z-19.53-2414,Z-19.17-1719
ATEX:	no
Odour trap:	included

Dimensions

Net weight:	2,99 kg
-------------	---------

Gross weight:	3,75 kg
Diameter:	135 mm
Type of height adjustability:	vertically adjustable upper section
Length:	135 mm
Width:	135 mm
Packaging dimension:	length
Packaging dimension:	width
Packaging dimension:	height
Tank/drain body	
Number of outlets:	1
Material of drain body:	Ecoguss
Socket version:	vertical
Coverage features	
Type of cover:	Slotted cover
Cover material:	Stainless steel 14301
Colour of cover:	silver
Width of cover:	138 mm
Length of cover:	138 mm
Min. flooring height:	10 mm
Frame material:	Stainless steel 14301
Locking:	screwed
Load class:	K 3 (EN 1253-1)
Rim width:	150 mm
Rim length:	150 mm
Max. flooring height:	17 mm
Upper section:	adjustable in three dimensions
Upper section material:	ABS